



# **SJR3-5000 Series High Performance Soft Starter**

## **Operation Manual**

**V1.0**

**Sanyu, control and protect your motors**

**Shanghai Sanyu Industry Co.Ltd.**

## Contents

Operating Instruction Manual(V1.0).....	- 4 -
Foreword.....	- 5 -
Excellent Performance .....	- 6 -
Typical Applications .....	- 7 -
Use and environmental conditions.....	- 7 -
Safety Precautions .....	- 8 -
1. Overview .....	- 9 -
1.1 Product features .....	- 9 -
1.2 Structural features .....	- 9 -
1.3 Introduction of product typical applications .....	- 10 -
1.4 Use and environmental conditions .....	- 10 -
1.5 Packing list .....	- 10 -
1.6 Working principle.....	- 11 -
1.7 Incoming inspection.....	- 11 -
2. Product Selection.....	- 12 -
2.1 Product nameplate .....	- 12 -
2.2 Model and definition .....	- 12 -
2.3 Precautions for selection .....	- 12 -
3. Installation.....	- 13 -
3.1 Outer dimension of soft starter .....	- 13 -
3.2 Requirements of installation.....	- 14 -
4. Wiring .....	- 15 -
4.1 Application wiring diagram .....	- 15 -
4.1.1 Main circuit connection diagram of soft starter .....	- 15 -
4.1.2 Configuration diagram of terminals .....	- 15 -
4.1.3 Primary and secondary wiring diagram .....	- 16 -
5.1 Description for displaying the keyboard .....	- 17 -
5.2 Buttons.....	- 17 -
5.3 Function and parameter table .....	- 18 -
5.4 Functions selection and description .....	- 20 -
5.5 Parameter modification .....	- 25 -
5.6 Help information and description.....	- 25 -
5.7 Protection function and description .....	- 25 -
6. Faults Analysis.....	- 27 -
6.1 Overview .....	- 27 -
6.2 Common problems and countermeasures .....	- 27 -
6.3 Fault codes and solutions .....	- 28 -
7. MODBUS Communication Protocol.....	- 30 -
7.1 Overview about Modbus RTU communication protocol .....	- 30 -
7.2 Related setting of soft starter .....	- 30 -
7.3 Abnormal response.....	- 32 -
7.4 Precautions for use .....	- 33 -

8. Precautions of Use and Daily Maintenance for SJR3-5000.....	- 34 -
8.1 Precautions for application use .....	- 34 -
8.2 Daily maintenance of soft starter .....	- 35 -
Warranty Agreement .....	- 38 -

## Operating Instruction Manual(V1.0)

- Please read the instruction manual carefully and understand the contents so as to be able to correctly install, connect the circuit, operate and maintain, etc..
- The technical specifications of this product may change without notice.
- This instruction manual should be kept until the product is scrapped.
- This instruction manual should be kept in the hands of the actual end user.

## Foreword

Thank you for using SJR3-5000 Series intelligent AC motor soft starter produced by Shanghai Sanyu Industry Co.Ltd

SJR3-5000 Series soft starter is a intelligent AC motor soft starter with international leading technology newly developed by Shanghai Sanyu Industry Co.Ltd. SJR3-5000 Series soft starter uses power electronic technology, microprocessor technology and modern control theory technology, and has a new type of starting equipment with the international advanced level. This product can effectively limit the starting current of asynchronous motors when starting, and can be widely used in heavy-duty equipment such as fans, water pumps, conveyors, and compressors. It is an ideal replacement product for star/delta conversion, auto-coupling step-down, magnetic control step-down and other step-down starting equipment.

The SJR3-5000 Series soft starter not only has the same excellent performance as the international high-end soft starter, but also combines the application characteristics to further strengthen the reliability of the product, the adaptability of the environment, and the humanized and industrialized design, which can meet the requirements of various applications.

## Excellent Performance

- Multi-start mode:

The voltage ramp starting mode can obtain the max. output torque, the constant current soft starting mode can obtain the max. limited starting current, and the sudden jump starting mode can be applied to loads with large static friction during starting.

- High reliability:

There are high-performance microprocessors for digital processing of the signals in the control system, avoiding excessive adjustments of the previous analog circuits, thereby obtaining excellent accuracy and execution speed.

- High performance:

Programmable delay start mode, programmable interlock control.

There is no phase sequence requirement for input power.

The starting time and stopping time can be modified digitally.

The dynamic fault memory function makes it easy to find the cause of the fault and can record up to ten faults.

- Full dynamic control monitoring starter of field-bus, easy to network:

The bus type is Modbus.

- With multiple protection functions:

Protects against over-voltage, under-voltage, overheating, phase loss, and motor overload.

- Perfect humanized design:

Harmony of beautiful appearance and reasonable structure.

Harmony of perfect functions and easy operation.

Harmony of firmness, reliability and compact structure.

Artistic design of industrial products excellence.

- Reliable quality assurance:

Using computer simulation design.

STM patch production process.

Excellent electromagnetic compatibility performance.

High temperature aging and vibration test of the entire machine before leaving the factory.

- Fast and thoughtful after-sales service:

Reliable performance and quality lay the foundation for quality service.

Provide excellent and complete equipment design solutions.

Timely and thoughtful use consultation.

Continuously improve product performance based on user's opinion.

## Typical Applications

- Water pump

Using the soft stop function, the water hammer phenomenon of the pump is relieved when the pump is stopped, and the cost of system maintenance is saved.

- Ball Mill

Using voltage ramp to start, reduce the wear of gear torque, reduce maintenance workload, save time and save money.

- Fan

Reduce belt wear and mechanical shock, saving maintenance costs.

- Compressor

The use of current limiting realizes smooth starting, reduces motor heating and prolongs service life.

- Crusher

Using locked-rotor protection and fast protection to avoid mechanical failure or blockage causing the motor to overheat and burn.

- Conveying machinery

Realize a smooth and gradual starting process through soft start, avoid product displacement and liquid overflow.

## Use and environmental conditions

- Main circuit power supply: three-phase AC 380V (- 10%, + 15%), 50Hz±0.5%

Note:The above data only applies to this manual

- Control circuit power supply: built-in AC380V 50Hz

- Applicable motor: general squirrel-cage asynchronous motor.

- Starting frequency: It is recommended to start and stop no more than 20 times per hour.

- Cooling method: natural air cooling.

- Installation method: wall-mounted.

- Protection level: IP20 ~ IP30, depending on the power level. below 75kW is IP30, 75kW and above is IP20









- Environmental conditions: If the altitude exceeds 2000 m, the capacity should be reduced accordingly.

Ambient temperature is between -25~ ± 40°C.

Relative humidity does not exceed 95% (20C~65C), non-condensing, flammable, explosive, corrosive gas, no conductive dust.

Install indoors with good ventilation. The vibration is less than 0.5g.

## Safety Precautions

-  Please be sure to read this operating instruction carefully before installation.
-  The soft starter must be installed by professional technicians.
-  The specifications of the motor must be matched with this soft starter.
-  It is strictly forbidden to connect capacitors to the output terminals (U, V, W) of the soft starter.
-  After installation, the exposed terminals must be wrapped with insulating tape.
-  The soft starter or other related equipment should be reliably grounded.
-  The input power must be cut off during equipment maintenance.
-  Do not disassemble or modify this product without authorization.



## 1. Overview

This soft start controller takes an advanced microprocessor as the core, applies advanced software design methods and the latest hardware technology, uses thyristor phase shift technology, and realizes the soft start and soft stop functions of AC asynchronous motors, which has the multiple protection functions such as voltage, under-voltage, over-current, overload, three-phase unbalance, short circuit, etc.

The soft starter covers 5.5KW~630KW, with reliable quality and good electromagnetic compatibility (EMC). It can be widely used in heavy-duty equipment such as fans, water pumps, ball mills, crushers, conveyors and compressors. It is an ideal replacement product for star/delta conversion, auto-coupling step-down, magnetic control step-down and other step-down starting equipment.

### 1.1 Product features

- Using high-performance single-chip microcomputer and digital logic control technology, it has strong anti-interference ability.
- Starting parameters can be flexibly set according to different loads to obtain the best current curve and best torque control characteristics.
- It provides a smooth and gradual starting process for the motor, reduces the impact of the starting current on the power grid, reduces the vibration and noise of the equipment, extends the service life of the mechanical transmission system, and improves the working environment of the workers.
- The starting current can be adjusted according to the load to reduce starting loss and generate the best torque with the minimum current.
- There is no phase sequence requirement for input power.
- It can be set to free parking and soft parking, and the soft parking time can be adjusted.
- With standard RS485 interface and ModBus protocol (order statement).
- Using 4 x 8 LCD, parameter modification, easy and intuitive operation.
- The product has novel structure, reliable performance, strong function and easy installation and operation.

### 1.2 Structural features

- Soft starter: Natural air cooling, external AC contactor.
- Intelligent starting cabinet: Exquisite structure, simple installation.

### 1.3 Introduction of product typical applications

- The products are widely used in thermal power generation, hydropower, transmission and distribution equipment, metallurgy, chemical industry, mining, construction and other industries.
- Water pump---Using the soft stop function, the water hammer phenomenon of the pump is relieved when the pump is stopped, and the cost of system maintenance is saved.
- Ball mill-Using voltage ramp to start, reduce the wear of gear torque, reduce maintenance workload, save time and save money.
- Fan--Reduce belt wear and mechanical impact, saving maintenance costs.
- Compressor---Using current limiting to realize smooth starting, reduces motor heating and prolongs service life.
- Belt conveyor---Realize a smooth and gradual starting process through soft start, avoid product displacement and liquid overflow.

### 1.4 Use and environmental conditions

Use category: AC-53b

Rated insulation voltage: 660V

Rated impulse withstand voltage: 6KV

Rated limit short-circuit current: 10KA

Rated voltage: 380V±15%, AC three-phase symmetrical power supply;

Frequency: 50Hz/60Hz+2%

Number of starts: 12 times/min

Cooling method:The soft starter is naturally air-cooled, and the fan of the intelligent soft-start cabinet is cooled.

Installation method:Wall-mounted or vertical cabinet

Protection level: IP20 ~ IP30, depending on the power level. below 75kW is IP30, 75kW and above is IP20.

Running height: 1000 meters without capacity reduction (above 1000 m, for every additional 100 m, the current is reduced by 0.5%)

Ambient temperature:store: -25°C~+70°C

Operating temperature: -5°C~+55°C, above 40°C, the current is reduced by 2% per liter of 1°C

Relative humidity:Max. 90% (temperature is 20°C)

Pollution level: Level III

### 1.5 Packing list

a. Soft starter; b. User manual; c. Certificate; d. Quality service card.

## 1.6 Working principle

The principle block diagram of this soft starter is shown as in Fig. 2. The power part is composed of three pairs of anti-parallel thyristors as shown in Figure 1. The core microprocessor of the control part collects the synchronization signal, voltage signal, current signal and motor power factor angle of the power grid. The control software changes according to these four parameters. Using the thyristor phase shift technology, the voltage applied to the motor slowly reaches the full voltage according to a certain rule. By setting the control parameters appropriately, the torque and current of the motor can be better matched with the load requirements.

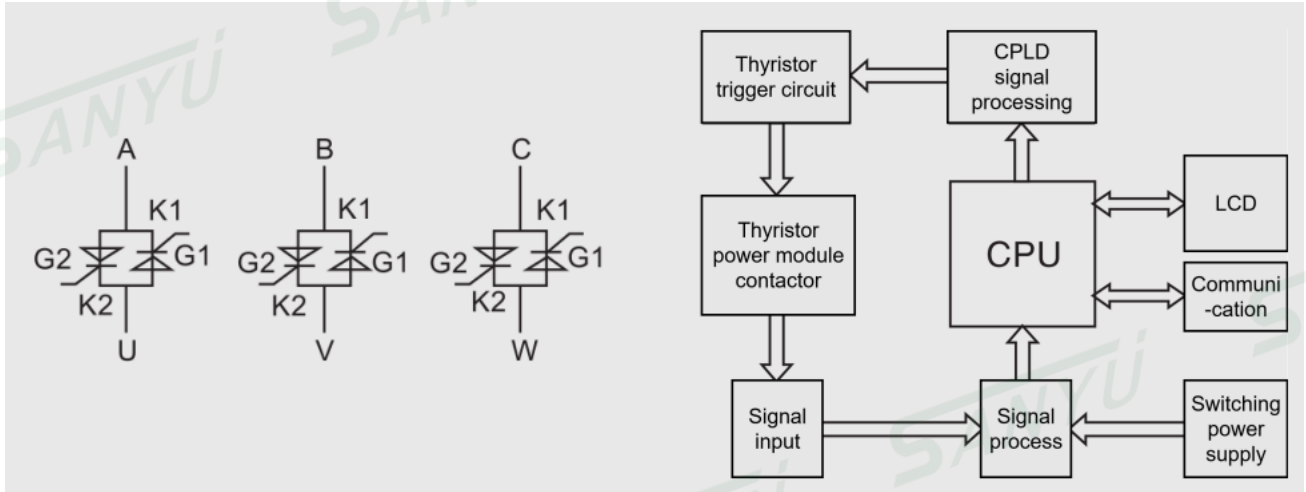

Fig.1 Thyristor power module

Fig.2 principle block diagram

## 1.7 Incoming inspection

- Before taking the soft starter out of its packaging materials, please make sure that the packaging carton has not been damaged during transportation. Damage to packaging cartons is usually caused by improper transportation. If you find any damage, please notify the carrier and your dealer representative.
- Please confirm that the nameplate and label of the soft starter conform to the packing list and the corresponding purchase order. If the soft starter is not installed immediately, it should be stored in a clean and dry area with an ambient temperature of  $-25^{\circ}\text{C}\sim+70^{\circ}\text{C}$ .

## 2. Product Selection

### 2.1 Product nameplate



### 2.2 Model and definition

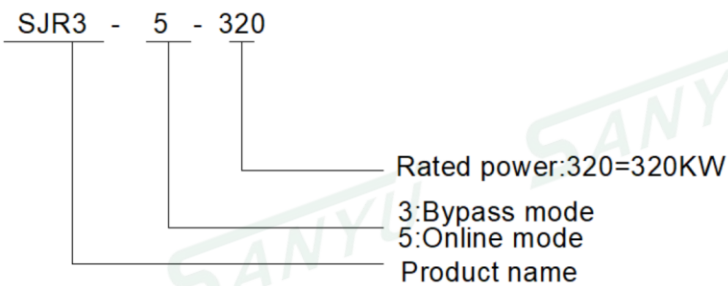

### 2.3 Precautions for selection

The soft starter must provide a force greater than the load resistance moment to complete the start-up. For ordinary loads such as water pumps, fans, etc., it is recommended to configure soft starters with the same or higher gear specifications, and for heavy loads such as ball mills, grade 6 fans and crushers, it is recommended to configure soft starters with high or second gear specifications.

### 3. Installation

#### 3.1 Outer dimension of soft starter

① Structure and dimension of product for SJR3-5000 Series 5.5KW-45KW

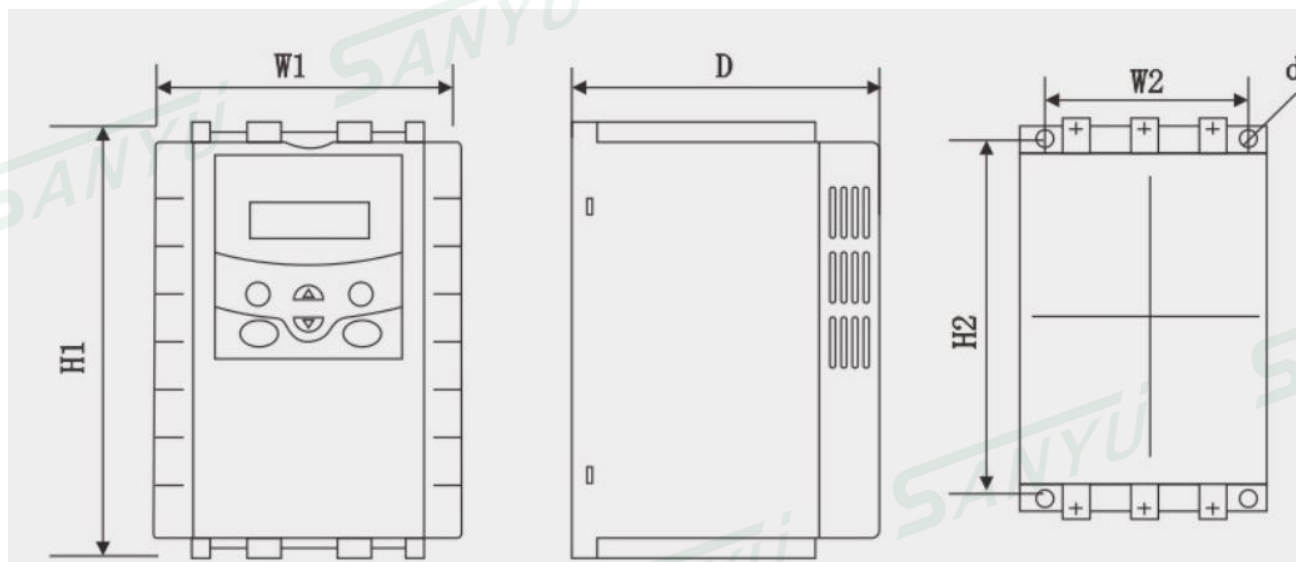

Model	Rated power (kw)	Rated current (A)	Outer dimension(mm)			Installation dimension(mm)		
			W1	H1	D	W2	H2	d
SJR3-5005	5.5	11	155	250	190	143	235	M6
SJR3-5007	7.5	15	155	250	190	143	235	M6
SJR3-5011	11	23	155	250	190	143	235	M6
SJR3-5015	15	30	155	250	190	143	235	M6
SJR3-5018	18.5	37	155	250	190	143	235	M6
SJR3-5022	22	45	155	250	190	143	235	M6
SJR3-5030	30	60	155	250	190	143	235	M6
SJR3-5037	37	75	155	250	190	143	235	M6
SJR3-5045	45	90	155	250	190	143	235	M6

②Structural dimension of product for SJR3-5000 Series 55KW or more

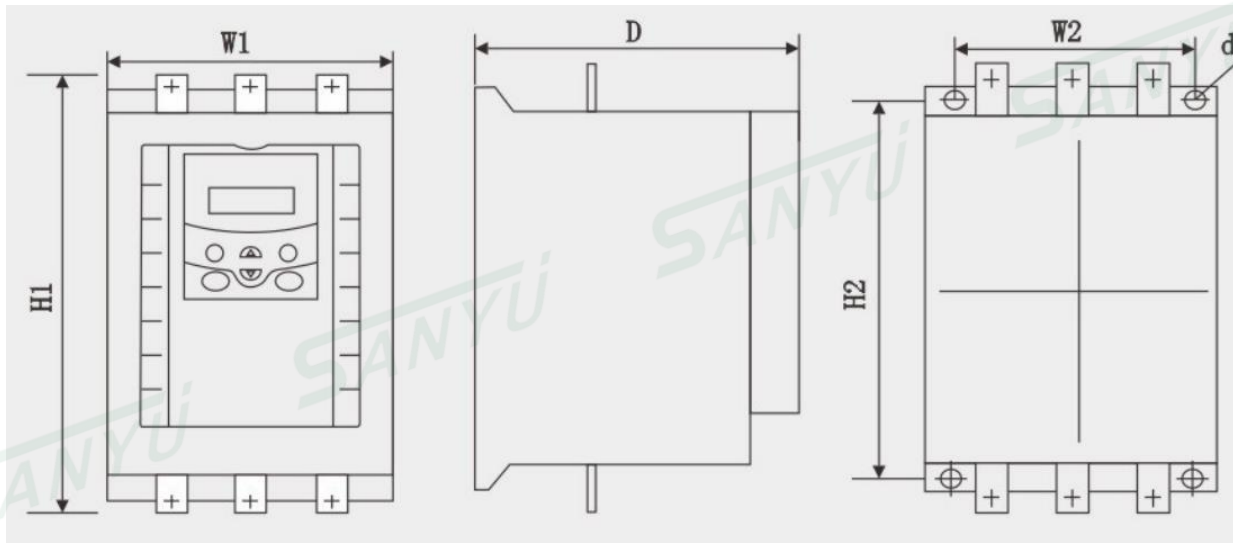

Model	Rated power (kw)	Rated current (A)	Outer dimension(mm)			Installation dimension(mm)		
			W1	H1	D	W2	H2	d
SJR3-5055	55	110	228	335	213	165	300	M6
SJR3-5075	75	150	228	335	213	165	300	M6
SJR3-5090	90	180	210	380	243	150	333	M8
SJR3-5115	115	230	320	435	248	260	375	M8
SJR3-5132	132	260	320	435	248	260	375	M8
SJR3-5160	160	320	320	435	248	260	375	M8
SJR3-5185	185	370	380	468	273	320	400	M8
SJR3-5200	200	400	380	468	273	320	400	M8
SJR3-5220	220	440	380	468	273	320	400	M8
SJR3-5250	250	500	380	468	273	320	400	M8
SJR3-5280	280	560	470	540	290	335	460	M8
SJR3-5320	320	640	470	540	290	335	460	M8
SJR3-5400	400	800	470	670	290	335	530	M8
SJR3-5450	450	900	470	670	290	335	530	M8
SJR3-5500	500	1000	470	670	290	335	530	M8
SJR3-5630	630	1200	620	775	320	560	660	M8

### 3.2 Requirements of installation

#### Direction of installation

- ①The soft starter must be installed in the vertical direction, not upside down, it should be installed on a firm structure with screws.
- ②The soft starter must generate heat when it is running. To ensure the passage of flowing air, The design leaves a certain amount of space. The generated heat is dissipated upwards, so do not install under heat-sensitive equipment.
- ③The main circuit uses top in and bottom out, and the wire should ensure sufficient carrying capacity of current.

## 4. Wiring

### 4.1 Application wiring diagram

#### 4.1.1 Main circuit connection diagram of soft starter

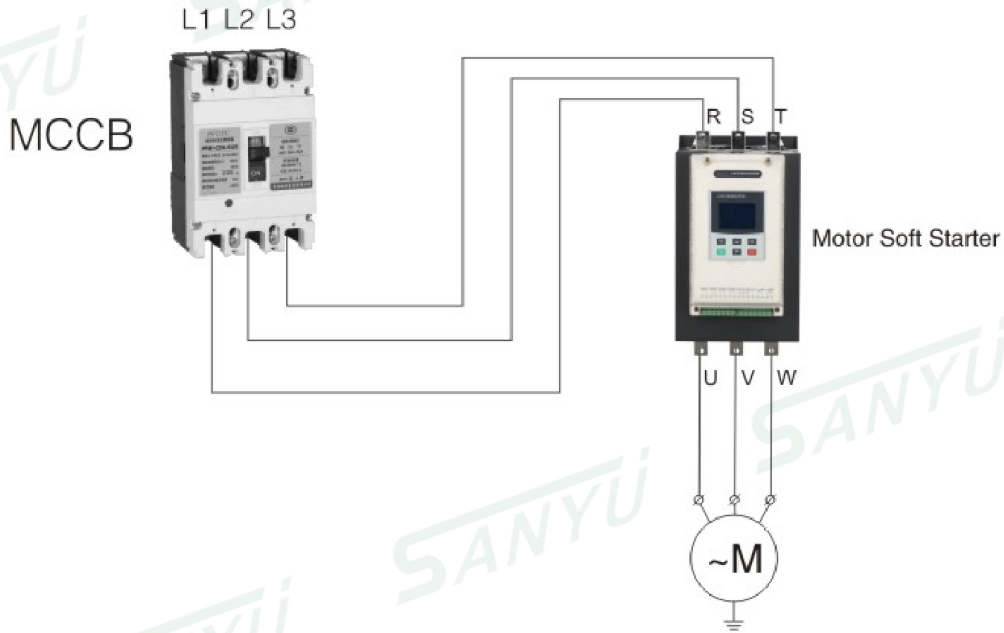

#### 4.1.2 Configuration diagram of terminals

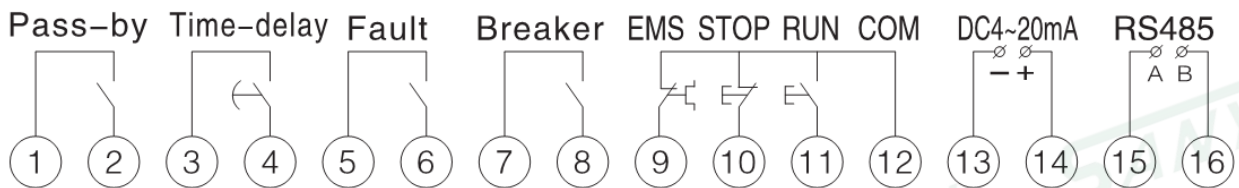

### 4.1.3 Primary and secondary wiring diagram

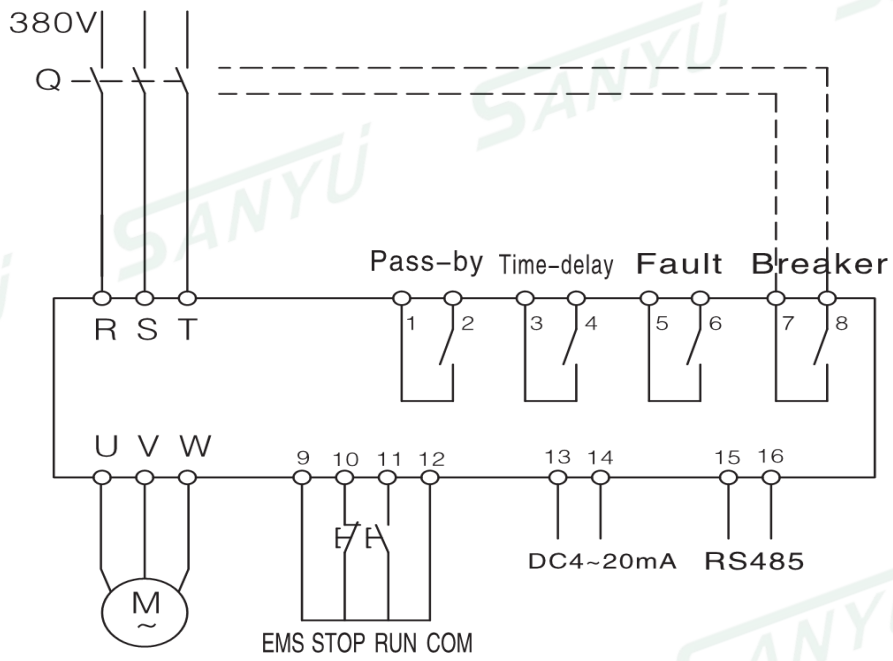





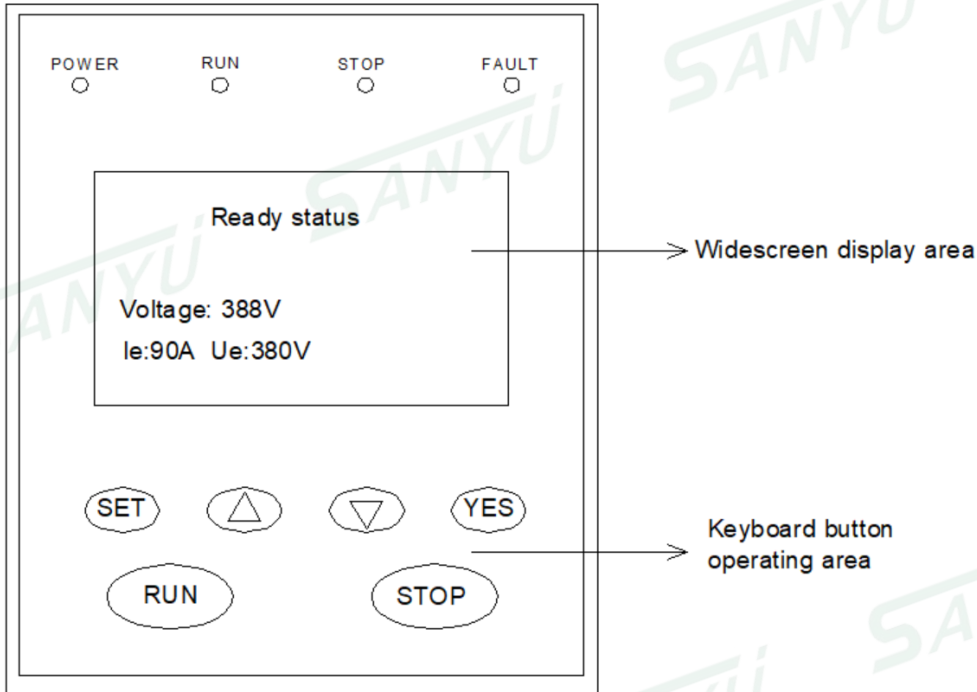

## 5. Display for Keyboard Interface

### 5.1 Description for displaying the keyboard



### 5.2 Buttons

Button name	Description of functions
YES	<ol style="list-style-type: none"> <li>1. In the ready state, press [YES] to enter the help menu, and then press [YES] to exit. You can also press [Stop Reset] to exit.</li> <li>2. In the setting state, press [YES] to save the new data and exit the setting state.</li> </ol>
SET	<ol style="list-style-type: none"> <li>1. In the ready state, press the [SET] button to enter the function parameter menu and display "FX: XXX"; at this time, press the [▲] ([▼]) button to display the next (previous) parameter value.</li> <li>2. Press the [SET] button again to enter the setting state. At this time, the colon is flashing. Then you can press [▲][▼] button to modify the parameter value after the colon. Press [YES] when the colon is flashing. If the data has been modified, it will display: "Data storage completed", and it will beep twice, indicating that the new data has been saved, and then exit. If you don't want to save the new data, press the [Set] button, the colon stops flashing and restore the original data, and then press the [YES] button to exit. You can also press [Stop,] to exit directly.</li> </ol>

Button name	Description of functions
 	<p>1. In the setting menu, when the colon is not flashing, press [▲], [▼] button to change the function number; when the colon is flashing, press [▲], [▼] button to change the data, press and hold[▲],[▼]button for more than 1 second, the data will be increased or decreased in rapid succession.</p> <p>2. Press [▲], [▼] button in the help menu to change the content of the corresponding help prompt information. In bypass operation, and the setting and help menu is not entered, the motor running current is displayed. Press the [▲], [▼] button at this time to select and display the inspecting power of the motor or the thermal balance coefficient of the motor overload. When the indicated value of the thermal balance coefficient is greater than 100%, overload protection will be performed.</p>
	The motor can be started only when the setting keyboard of function parameter FB is valid, otherwise, the button cannot start the motor
	When the setting keyboard of function parameter FB is valid, the keyboard can be stopped. Otherwise, the machine can not be shut down by pressing this button, and the function is "Reset" in the fault state.

### 5.3 Function and parameter table

Function code	Name	Setting range	Factory value	Description
F0	Starting voltage	30-80%	30%	Voltage ramp mode is valid; Starting voltage of current mode is 40%
F1	Soft starting time	02-60S	16S	Voltage mode is valid
F2	Soft stopping time	00-60S	2S	Free stop when set to 0
F3	Starting over-current Protection time	00-60S	00S	During starting the motor, when the time of more than 3 times the rated current exceeds the setting value of this parameter, the over-current protection will be activated
F4	Programming delay	00-999S	00S	For programmable relay output
F5	Starting current limit	50-500%	280%	Current limiting mode is valid; The max. current limit in voltage ramp mode is 400%
F6	Max. working current	50-200%	100%	Relative to the value of rated current FP

Function code	Name	Setting range	Factory value	Description
F7	Under-voltage protection	49-90%	70%	Under voltage protection when it is lower than the set value, when it is set to 49%, turn off the function
F8	Over-voltage protection	100-131%	120%	Over-voltage protection when higher than the set value, when set to 131%, turn off the function
F9	Starting mode	00-06	01	00 current limit; 01 voltage; 02 sudden jump + current limit; 03 sudden jump + voltage; 04 current ramp; 05 double closed loop; 06 full voltage
FA	Protection level	00-05	02	00 basic protection 01 Light load protection; 02 Standard protection;; 03 Heavy load protection;; 04 the bestt protection; 04 Close three-phase unbalance protection;
FB	Control method	00-06	04	00 Keyboard; 01 Keyboard+external control; 02 external control; 03 external control + communication; 04 keyboard + communication+external control; 05 keyboard + communication; 06 communication
FC	Parameter modification allowed	00-02	01	00: It is forbidden to modify any parameters except the setting item FC; 01: It is forbidden to modify the parameters of F4, F5, F6, FD, FE, FU, FL, FM, FN; 02: It is allowed to modify the parameters of all functions
FD	Communication address	0-64	00	Used for MODBUS local slave address setting
FE	Programming output	00-19	06	Used to define ③-④ terminal output See the description in section 5.4 for details
FF	Turn-stop current limit	30-100%	80%	
FP	Rated current valve of motor		Rated value	Used to enter the nominal rated current value of the motor
FU	Bypass delay	1-40S	3S	Used to set the time of bypass delay
FL	Three-phase imbalance	00-01	01	00:Three-phase imbalance prohibited, 01: Three-phase imbalance allowed
FM	Current ratio	50-150%	100%	Used to adjust the display current value
FN	Voltage ratio	50-150%	100%	Used to adjust the display voltage value

Remarks:

1. The max. working current of setting item F6 refers to the max. current that allows the motor to run continuously based on the FP setting value. If this value is exceeded, inverse-time thermal protection will be performed.
2. If there is no key operation for more than 2 minutes in the setting state, it will automatically exit the setting state.
3. Parameters cannot be set during soft start and soft stop, and parameters can be set in other states.
4. Press the[YES] button to power on, and the set parameters can be restored to factory values.

## 5.4 Functions selection and description

### 5.4.1 Code FE (programming output)

The programmable relay output function has two working modes:

① Programmable timing output mode and programmable state output mode

② When the setting item FE is 0~4 (10~14), the programmable output work is the timing output mode, and the starting time of the output is set as follows:

FE setting value	0(10)	1(11)	2(12)	3(13)	4(14)
Programming output time	When sending the starting command	When starting	During bypass running	When sending the stopping command	When the shutdown is complete

Note:

· This working mode includes a 999 second timer, which is set by the setting item F4. If F4 is not 0, start timing according to the starting time set by the setting item FE. When the timer expires, the output changes state. If the setting item F4 is 0, the output state will be changed immediately. The reset time of this output is to set the time by pressing F4, and the end of the delay is to maintain 1 second in the ready state.

· Programmable timing output takes a starting process as the control cycle. If the motor is started again, it will automatically interrupt the previous programmed output process and restart the process.

③ When the setting item FE is 5~9 (15~19), the programmable output (FE) works in the state output mode, and the set working state output is as follows:

FE setting value	5(15)	6(16)	7(17)	8(18)	9(19)
Output indication state	Motor fault state	Operating state	Ready state	Starting state	Bypass state

• The programmable status output mode is used to indicate the working state of the soft starter. In this mode, the time set by the setting item F4 (programming delay) is invalid. When the programmable output is in the fault state, it refers to an electrical fault (Err05, Err06, Err07, Err08, Err12, Err15), which is different from the function of the fault output terminals ⑤ and ⑥. The running status refers to the non-ready or fault state, which includes three processes of start, bypass and soft stop.

· When FE > 9, the positioning state of external terminals ③ and ④ of programmable output will change from normally open to normally closed, i.e, reverse output. Flexible use of programmable relay output function can effectively simplify the same peripheral control logic circuit.

### 5.4.2 Code F0 (starting voltage) F1 (rise time)

They are the starting control parameters in voltage mode. Increasing the starting voltage helps to overcome the static friction of the load starting; the greater the load inertia, the longer the rise time (Fig. 5.4.2)

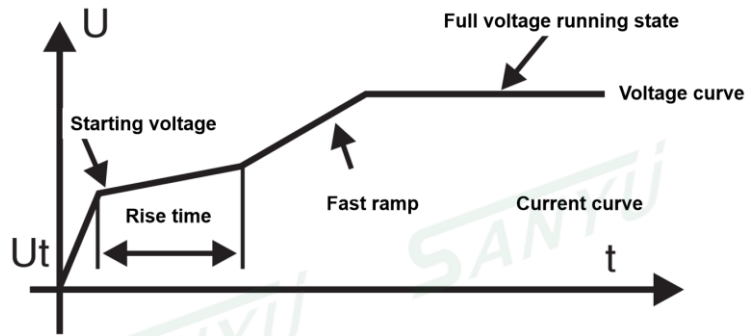

Fig 5.4.2

#### 5.4.3 Code F2 (soft stop time)

When the stopping time is set to 0, it is a free stop. Too long stopping time will bring instability to the system. (Fig.5.4.3)

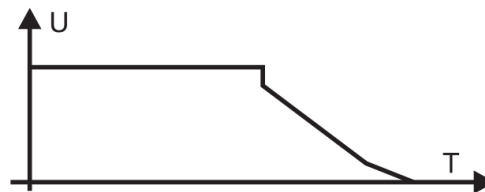

Fig. 5.4.3

#### 5.4.4 Code F5 (Starting limit current)

When using this function, code F9 must be set to 0 or 2 or 4, and the starting current of the starter will run below the set value (50% - 500%). After starting, the current will drop below the rated value. The larger the set value, the shorter the starting time. Note that this value cannot be set too small. If it is too small, a "Too long starting time" fault will occur. (Figure 5.4.4)

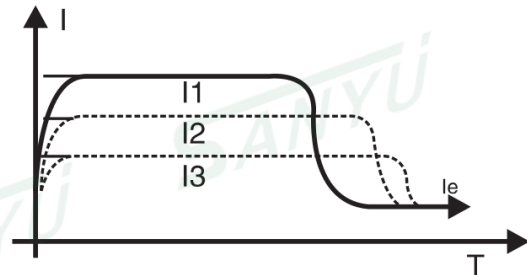

Fig. 5.4.4

#### 5.4.5 Code F6 (load regulation rate)

When the rated parameters of the soft starter selected by the user do not match the actual motor, in order to make the protection function and display parameters correct, the load regulation rate should be reset.

$$KT = \frac{P_s}{P_r} \%Ps$$

Definition of load regulation

Is the actual rated current of the motor, Pr is the rated current of the soft starter

For example: The user's motor is 200A, and the rated current of soft starter is 400A, then the set value of code F6 is changed to 50%

#### 5.4.6 Code F9 (starting mode)

The intelligent controller has 7 starting modes to adapt to various complicated motor and load conditions. Users can select according to different application conditions.

#### Working principle

##### 00 limited current starting mode:

When the setting item F9 is 0, set the starting mode to this mode.

Fig. 5.4.4 shows the change waveform of the electrical current in the current limiting starting mode. Where |1 is the set starting current limit value. When the motor starts, the output voltage increases rapidly until the motor current reaches the set current limit value|1, and the motor current is not greater than this value, and then as the output voltage gradually increases, the motor gradually accelerates. When the motor reaches the rated speed, the output current quickly drops to

the motor rated current $\leq 1$  or below, and the starting process is completed.

When the motor load is lighter or the set current limit value is large, it is normal that the maximum current at starting may not reach the set current limit value.

Current limiting starting mode is generally used in occasions that have strict requirements on starting current.

**01 Voltage ramp starting mode:**

When the setting item F9 is 1, set the starting mode to this mode.

Fig. 5.4.2 shows the output voltage waveform of voltage ramp start. When the motor starts, the output voltage of the soft starter rises rapidly to the initial voltage value within the range of the motor current not exceeding 400% of the rated value, and then the output voltage gradually rises according to the set starting parameters. The rise continues to accelerate steadily. When the voltage reaches the rated voltage  $U_e$ , the motor reaches the rated speed and the starting process is completed.

The starting time is the control parameter obtained under the standard load under standard conditions. The controller uses this parameter as a benchmark to smoothly accelerate the motor to complete the starting process by controlling the output voltage. It does not mechanically control the starting time value regardless of whether the motor accelerates smoothly. In view of this, when the load is light, the starting time is often less than the set starting time, as long as it can be started smoothly, it is normal.

**02 or 03 sudden jump start mode:**

When the setting item F9 is 2 or 3, set the starting mode to this mode.

Figure 5.4.6a and figure 5.4.6b show the output transformation waveform of jump start mode. This mode can be used when the motor cannot be started due to the influence of mechanical friction in some heavy load cases. When starting, first apply a higher fixed voltage to the motor for a limited period of time to overcome the static friction of the motor load to make the motor rotate, and then start by the current limit (Figure 5.4.6a) or voltage mode (Figure 5.4.6b) .

Before using this mode, you should start the motor in non-sudden jump mode. If the motor cannot rotate due to too much static friction, select this mode; otherwise, you should avoid starting in this mode to reduce unnecessary high current impact.

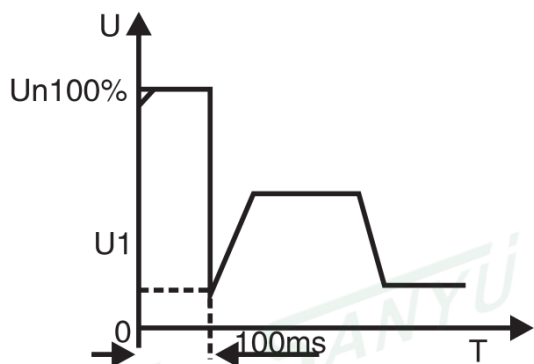

Fig.5.4.6a

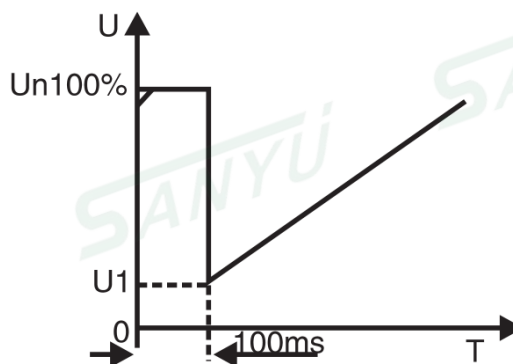

Fig.5.4.6b

**04 Current ramp starting mode:**

When the setting item F9 is 4, set the starting mode to this mode. Fig. 5.4.6c is the output current waveform of the current ramp start mode, where  $I_1$  is the current limit value set by F5, and  $T_1$  is the time value set by F1.

The current ramp starting mode has a strong acceleration capability, which is suitable for two-pole motors and can also shorten the starting time within a certain range.

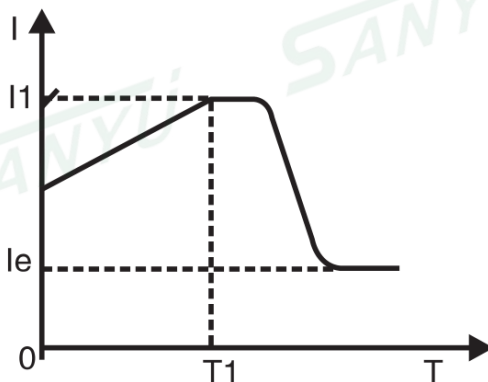

Fig.5.4.6c

#### 05 Double closed loop starting mode of voltage current limit:

When the setting item F9 is 5, set the starting mode to this mode.

**Double closed loop starting mode of voltage current limit** uses voltage ramp and current-limiting double closed-loop control. It is a comprehensive starting mode that requires both stable starting and strict current limiting. It uses a predictive algorithm for estimating the working state of the motor.

The output voltage waveform of this starting mode will vary according to the motor and load conditions.

#### 06 Monitor starting mode:

Starting in this mode, it will run in direct starting mode. It can monitor the parameters such as the motor running current. When the operation is overloaded, over-voltage or under-voltage, the fault output 5 and 6 terminals are disconnected from the output, and the corresponding fault information is displayed at the same time.

#### 5.4.7 Code FA (protection level)

In order to adapt to different applications, the protector has five protection levels, namely 00: primary, 01: light load, 02: standard, 03: heavy load, 04: advanced, which are set by the setting item FA. among them:

- The primary protection only retains the overheating, short circuit and input phase loss protection during starting, which is suitable for occasions requiring unconditional emergency starting.
- The three protection levels such as light load, standard and heavy load have complete protection functions. The difference is that the protection time curve of motor overload is different. The motor thermal protection time parameters are shown in Table 5.4.7 and Fig.5.4.7.
- The protection standard of advanced protection is stricter when starting, and other protection function parameters are the same as the standard protection setting time.



The different protection levels and thermal protection time set by the setting item FA are as follows: Table 5.4.7

FA setting	0 (primary)	1 (light load)			2 (standard)			3 (heavy load)			4 (Advance)			Description
Running overload Protection level	None	Level 2			Level 10			Level 20			Level 10			Based on the standard of IEC60947-4-2
Starting over-current Protection time	None	3 seconds			15 seconds			30 seconds			15 seconds			Set 5 times as the starting current exceeds F6
Running overload Tripping time table	Current multiple (I/le)	3	4	5	3	4	5	3	4	5	3	4	5	Values in the table Typical value
	Tripping time (sc)	4.5	2.3	1.5	23	12	7.5	48	23	15	23	12	7.5	

- The specification of soft start should be set according to the requirements of rated current and rated voltage of motor.

The tripping time curve of motor thermal protection according to IEC60947--4-2 standard is as follows:

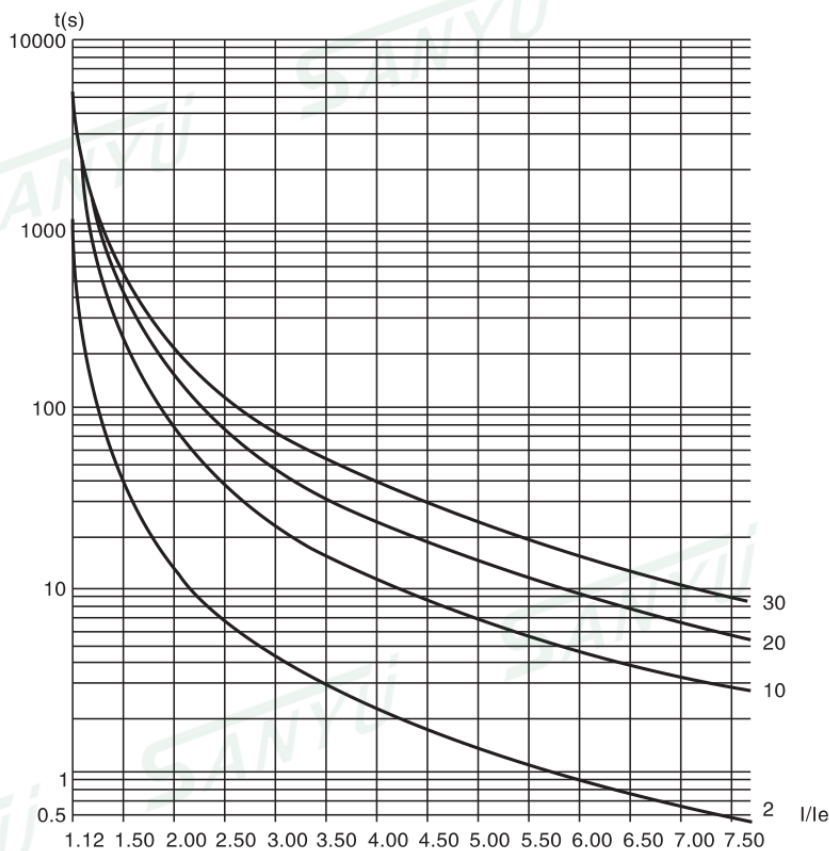

Fig. 5.4.7



## 5.5 Parameter modification

### 5.5.1 Modification of function parameter

#### (1) Operating flow chart

Power ON→



Power-on→Press the SET button→Press UP/DOWN button→Press the SET button→Press UP/DOWN button→Press “YES” button

Enter code options →Select code function →Determine modified code →Modify the setting range→Save the modified data (Exit)

## 5.6 Help information and description

Display	Description
AC: XXX Power voltage	3-digit digital voltmeter for monitoring the voltage of three-phase AC power supply.
400A- -380V Specification of soft start	Display the specification of this soft starter is 400A/380V.
H1: Error05 Output phase loss	Display the last fault message Err05 (and so on).
.....	.....
H9: Error00 No faults	Display no fault information.
UEr3.0 Software version No.	Display the version of this software is Ver3.0.
Lxxx Times of successful starts	Where XXXX is the total times of successful starts.
Time-run xx Starting time	Where XX is the time of last start (whether successful or not).
Note: H1-H2 use recursive method to store 9 newly occurred fault information.	

-In the state of non-soft start and soft stop, and not enter the setting state, press[YES] to enter the help menu, and then press [▲], [▼] button to select the prompt information.

-In the help state, press[YES] or [Stop] to exit the help state.

## 5.7 Protection function and description

This Soft Starter Series soft start controller has a variety of protection functions. Any failure will lead to shutdown and display the failure prompt. In use, the protection level and parameters should be set appropriately according to different situations.

**Protection function and other parameter:**

·Overheating protection of soft starter:

When starting the soft start, if the temperature rises to  $80^{\circ}\text{C}\pm 5^{\circ}\text{C}$ , the protection will act. When the temperature drops to  $55^{\circ}\text{C}$  (minimum), the overheating protection will be released. (The thermal protection temperature switch needs to be connected to the J4 terminal of the controller)

By setting the parameter F3 (start interval delay) to define the min. time for two consecutive starts, the thyristor can also be effectively protected.

·The protection lag time of input phase loss: <3 seconds.

·The protection lag time of output phase loss: <3 seconds.

·The lag time of three-phase imbalance time : <3 seconds. Based on the current deviation of each phase greater than  $50\% \pm 10\%$ , when the load current is lower than 30% of the soft starter's nominal rated current, the standard deviation of judgement will increase.

Operating over-current protection time: inverse-time thermal protection and trip protection are based on the max. working current of the setting item F6

The time curve is shown in Fig. 4.7.

·The protection lag time of low power voltage: When the power voltage is lower than the set value, the protection action time is <3 seconds.

·The protection lag time of high power voltage: When the power voltage is higher than the set value, the protection action time is < 3 seconds.

·The protection lag time of loaded short circuit: <0.1 second, the current is more than 8 times of the nominal rated current of the soft starter.

Note:The above time parameters are from the detection of a valid signal until the trip protection command is issued. The parameter values are for reference only. If it does not meet the user's requirements, additional special protection devices should be added to ensure safety.

## 6. Faults Analysis

### 6.1 Overview

- When there is a problem with the soft starter application, this chapter will be used as a guide.
- When there is a problem with the soft starter application, the fault type will be displayed on the LCD.

### 6.2 Common problems and countermeasures

Abnormal phenomenon	Content of inspection	Countermeasures
The motor does not rotate	Check whether the cabling is abnormal and power cord is connected to the input terminals (R,S,T)	Please make correct cabling Connect to the power Cut off the power, then power on
	When the bypass operation mode is selected, check whether the bypass works and 01, 02 terminals are connected.	Check the connection of bypass contactor Check the connection of bypass contactor coil
	Check whether the keyboard has abnormal display	Please read the instruction sheet of function operation and fault solutions
	Check whether the motor has been locked (load is too heavy)	Please release the lock of motor (reduce the load)
Keyboard cannot start	Check whether 07,10 terminals are displayed and opened circuit, and code FB setting is normal	If no display: check whether power lacks of phase, and check the incoming power If display: check whether 10,07,08 are opened circuit, and check the external wiring of terminals, and set FB code correctly.
External control cannot start	Check whether code FB is set in external control	Check whether 10,07,08 are opened circuit, and check the external wiring of terminals, set FB correctly and whether it is in the external position.
The motor rotates but the speed does not change	Check whether the load is too heavy; and display current is greater than actual current	Please reduce the load Increase the starting voltage, enlarge the power of soft start, and adjust the display current

Starting time is too long	The load is too heavy The code is set incorrectly Check whether the specification is abnormal	motor Please reduce the load Please set FO (starting voltage), F5 (starting current limit) F1 (soft starting time) Please check specification instruction and nameplate
Starting time is too short	The load is too light The starting time is too short	When the load is light, the starting time is often less than the set value, and the starting balance belongs to the normal setting code F1 starting time (current mode is invalid)
Stop suddenly during operation	Check the external input terminals	Check whether the connection of 07 and 10 terminals are loose Check whether the connection line of external stop button is loose.

Abnormal phenomenon	Content of inspection	Countermeasures
The motor has hum No starting signal but the motor is starting	<ul style="list-style-type: none"> <li>•The SCR is short-circuited and broken through</li> <li>•The starting button is abnormal</li> </ul>	Check and replace Check and correct the reasons of faults
The motor sounds abnormal during start-up and operation	<ul style="list-style-type: none"> <li>•Motor phase loss</li> </ul>	Try different time to reduce the voltage (several adjustments may be necessary to obtain ideal results)
If you use external control to start, the motor cannot start	<ul style="list-style-type: none"> <li>•The control connection is incorrect</li> <li>•Start and stop signals are sent at the same time</li> </ul>	Check the connection of start and stop Check whether the start and stop signals are sent at the same time Check whether the keyboard is in the local control menu Check whether the parameter neutral control is not activated
When bus communication is used to input starting information, the motor will not start	<ul style="list-style-type: none"> <li>•The keyboard is in the local control menu</li> <li>•Bus parameter setting error</li> </ul>	Check whether bus control is activated Check whether it is allowed to use Check whether the programmable input is set correctly

### 6.3 Fault codes and solutions

Display and description	Problems and solutions
Error00 The fault has been solved	Faults such as under-voltage, over-voltage, or overheating has just occurred, and it is now normal, and the motor can be started after reset
Error01 External instantaneous stop terminal open circuit	Short-circuit the external control instantaneous stop terminal ⑦ and the common terminal 10, or connect it to the normally closed contact of other protection devices.
Error02 Soft starter overheated	Starting too frequently or the power of the motor does not match the soft starter

Error03 Soft starting time is too long	Too low current limit makes the starting time too long (more than 60s) The starting parameter setting is inappropriate or the load is too heavy, current capacity is insufficient, etc.
Error04 Input phase loss	Check input or main circuit fault, bypass contactor stuck in closed position and SCR open circuit
Error05 Output phase loss	

Display and description	Problems and solutions
Error06 Three-phase imbalance	Check whether the input three-phase power supply and the load motor are normal.
Error07 Starting over-current	Check whether the load is too heavy or the motor power does not match the soft starter
Error08 Over-load protection of operation	During starting: ①Check and correct the reasons of the overload, check whether the current limit multiple is not too low; ②Check whether the boost time during starting is not too long; ③Check whether the appropriate motor overload category is used; ④Check whether the parameter setting is correct. During the connection and operation: Check and correct the reasons of over-load
Error09 Too low power voltage	Check whether input power voltage or the parameter setting of setting item F7 is improper
Error10 Too high power voltage	Check whether input power voltage or the parameter setting of setting item F8 is improper
Error11 Setting parameter errors	Modify the setting parameters or hold down the[YES] button, power on and restore the factory settings
Error12 Load short-circuit fault	Check whether the load or SCR is short-circuited or the load is too large
Error13 Thyristor short-circuit fault	Check whether the thyristor is short-circuited or the temperature control switch is damaged
Error14 Stop terminal wiring error	When the external connection mode is allowed, the external control stop terminal is in an open state, so that the motor cannot be started.
Error15 Motor load fault	Check the reasons of under-load, and make correction Check whether the setting is in accordance with the operating condition

Remark:

1. Some fault phenomena are related to each other. For example, when the Error02 soft starter is reported to be overheated, it may be related to starting over-current or load short-circuit. Therefore, when checking the fault, comprehensive consideration should be given to accurately determine the fault point.
2. When the soft starter starts the motor successfully, it means it is already running. If it displays "running..." at this time. When the motor stops running, check that the DIP switch is in bypass mode.

## 7. MODBUS Communication Protocol

### 7.1 Overview about Modbus RTU communication protocol

Modbus is a serial asynchronous communication protocol. Its physical interface is RS485. Modbus is designed for modiconPL C and has the structural characteristics of PLC. In Modbus network control, the soft starter can be compared to a PLC for reading and writing. The soft starter maps the start-stop control, status information (current, fault, etc.) and function parameters to the holding register area (4XXX). It is read and written through the PL master station when in use.

#### 7.1.1 Electrical interface

RS485 half duplex

Communication parameters: Baud rate: 9600; 8 data bits; no parity bit; 1 stop bit. .

#### 7.1.2 Communication data format

Data format

Address code	Function code	Data area	CRC check
1 byte	1 byte	N bytes	2 bytes

### 7.2 Related setting of soft starter

#### 7.2.1 Register address

Register address	Operation code	Description of register function
40001	06	Control word
40002	03	Status word
40003	03	Current average value
40004	03	Fault code
40256-40273	03&06	Function code of soft starter
40274	03	Specification of rated current
40275	03	Specification of rated voltage
40290	03	Power voltage value

(1) Register not listed above is illegal and cannot be read or written. Otherwise, the slave station will report an exception code to the controller.

(2) All data addresses are referenced to 40,000. i.e, the address of the coil relay 40001 is 0001, and the address of 402567 is 0100 (hexadecimal).

### 7.2.2 Support code

Soft start only supports the following codes. If other codes are used, the exception code 01 will be given.

Code	03	06
Function description	Read register	Write a single register

Code 03 is only read by a single word (WORD)

### 7.2.3 Description of register

-40001 command register

Bit	Value	Description
0	1	Starter will start
	0	Remain status
1	1	Starter will stop
	0	Remain status
2	0-1	Reset the starter
3-15	0	Not used

For example: Make the soft starter with the slave address 02, the controller sends out 02 06 00 01 00 01, if the command is executed normally, the return code is 020600010001. Whether the starter can start normally should check the status register. If there is a fault, you should send 02 06 00 01 00 04 to reply.

- Register address 40002 status register

The status register reflects the status of the soft starter and is represented by a word.

Bit	Value	Description
0	1	Starting status
	0	Stopping status
1	1	Running status
	0	Stopping status
2	1	Soft stopping status
	0	Stopping status
3	1	Fault status
	0	Normal status
4-15		Not used

For example: Read status register code 020 300 02 00 01

If the starter is in the starting process, the return code 0203 02 00 01

If the starter fails, the return code is 02 03 02 00 08, and the type of fault can be read according to 4.

- 40003 current average value (hexadecimal)

This value reflects the average value of the three-phase actual current of the motor (including a decimal)

For example: reading current

Send code 02 03 00 02 00 01

If the current is 235A, return 0203 02 09 2E (return value is the actual current value)

- 40004 fault code (hexadecimal)

When the status register 40002 bit 3 is 1, it means that the soft start is in a fault state. The fault code is consistent with 6.1.

For example: Send code 02 03 00 04 00 01

If it returns 02 03 02 00 04, it means that the current input phase is missing (fault code 04).



Function parameter register 40XXX of soft starter

40256-40274 are function registers, the corresponding address is 0X0100-0X0112, the high byte address is 01, the low byte address is 0X00-0X12, and the corresponding function code F0-FL is consistent with the function code table 4.2. For example, address 0X109 corresponds to function code F9 (start mode). These codes can be read and written. The following examples give the description to its usage:

Example 1: Reading function code F5 (current limiting value)

Send code 02 03 0105 0001

Returns the value of the F5 function code read 020302015E means the current limit value is 350%

Example 2: Reading function code FA (Protection level)

Send code 02 03 01 0A 00 01

Return the value of the read FA function code 0203 02 00 03, and the read protection level is 3

Example 1: Rewrite the soft starter function code 05 (starting current) to 250%

The host sends the code 0206 01 05 00 FA, the soft start return code is 0206 01 05 00 FA; if it returns 0286 03 means unable to write, maybe the starter is running.

### 7.3 Abnormal response

Code	Name	Description
01	Illegal function	Function code cannot be executed, soft starter does not support
02	Illegal data address	The received data cannot be executed, and the address overflows
03	Illegal data value	The data received cannot be executed 1. The parameters are out of the limit 2. The parameters cannot be modified 3. When running, the parameters cannot be modified

#### 7.3.1 01 Illegal function code 01

Inquiry message format of master station:

Slave-station address	Function code	Starting address High byte	starting address Low byte	Number of registers High volume	Number of registers Low volume	CRC Check
0x01	0x08	0x00	0x80	0x00	0x0D	

This protocol does not use the 0x08 function code, so the slave station responds:

Slave-station address	Function code	Abnormal code	CRC check
0x01	0x88	0x01	

#### 7.3.2 Illegal function address 02

Inquiry message format of master station:



Slave-station address	Function code	Starting address High byte	starting address Low byte	Number of registers High volume	Number of registers Low volume	CRC Check
0x01	0x04	0x01	0x80	0x00	0x07	

04 function code register address is wrong, so the slave station responds:

Slave-station address	Function code	Abnormal code	CRC check
0x01	0x84	0x02	

### 7.3.3 Illegal data value 03

Inquiry message format of master station:

Slave-station address	Function code	Starting address High byte	starting address Low byte	Number of registers High volume	Number of registers Low volume	CRC Check
0x01	0x04	0x01	0x80	0x01	0x80	

04 function code register address is wrong, so the slave station responds:

Function code	Abnormal code	CRC check
0x84	0x03	

## 7.4 Precautions for use

- (1) The communication address, communication speed, and inspection mode of the soft starter must be the same as the communication settings of the controller.
- (2) If the response data cannot be received, check the above parameter settings, whether the connection to the 485 terminal is correct, and whether the CRC validation is correct.
- (3) When communicating with multiple SJR3-5000 units, a 120 ohm resistor should be connected to both ends of AB on the last unit.
- (4) When connecting with other Modbus devices, it should be connected as follows:

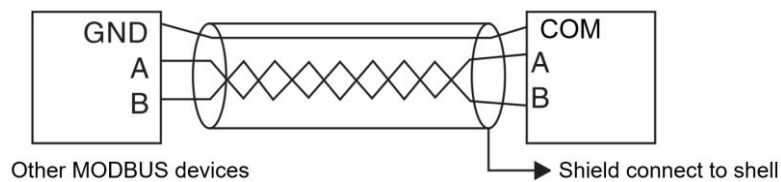

## 8. Precautions of Use and Daily Maintenance for SJR3-5000

### 8.1 Precautions for application use

- Prevent electric shock

After the input terminal of the SJR3-5000 soft starter is connected to the power supply, when the load is open circuit or phase loss, even in the stopping state, the output terminal will still have a fairly high induced voltage. Do not touch the output terminal of the soft starter, otherwise there will be a risk of electric shock.

The control circuit board of SJR3-5000 soft starter has a voltage of 380V, which may cause electric shock during commissioning.

- Induced voltage

The induced voltage at the output end of the SJR3-5000 soft starter at no load is normal and does not affect the use. The induced voltage is generated by the leakage of the RCR (solid-state semiconductor devices such as thyristor, GTR, IGBT, etc. have varying degrees of leakage) and the AC path of the dv/dt resistance-capacitance filter circuit. Use a voltmeter to measure zero, about 100~220V (related to the internal resistance of the voltmeter). The load capacity of this induced voltage is very small and disappears after the output is connected to the load.

- Compensation capacitor

The reactive power compensation capacitor used to improve the power factor must be connected to the input end of the SJR3-5000 soft starter, and must not be connected to the output end, otherwise it will damage the SCR power device in the soft starter.

- Megohmmeter

Do not use a megohmmeter to measure the insulation resistance between the input and output of the SJR3-5000 soft starter, otherwise the SCR and control board of the soft starter may be damaged due to over-voltage.

A megohmmeter can be used to measure the phase-to-phase and phase-to-ground insulation of the SJR3-5000 soft starter, but three short-circuit wires should be used to short-circuit the input and output terminals of the three phases in advance, and unplug all plugs on the control board.

When measuring motor insulation, the above principles should also be followed.

- Input and output

Do not connect the input and output terminals of the main circuit of the SJR3-5000 soft starter in reverse, otherwise it will cause unexpected actions of the soft starter and may damage the soft starter and motor.

- Bypass phase sequence

When using a bypass contactor, the phase sequence of the starting circuit should be consistent with the phase sequence of the bypass circuit, otherwise a phase-to-phase short circuit will occur during bypass switching, causing the air circuit breaker to trip and even damage the equipment.

- Low voltage level

The 7, 8, 9, 10, and 11 terminals use internal working voltage, and other external power supplies must not be connected to these terminals, otherwise the internal circuit of the soft starter will be damaged.

- Working voltage level of soft starter

13, 14 terminals use external AC380V working voltage, do not connect other voltage levels to these terminals. Otherwise, the internal circuit of the soft starter will be damaged.

## 8.2 Daily maintenance of soft starter

- Prevent electric shock and dust

If there is too much dust, the insulation level of the soft starter will be reduced and the soft starter may not work properly.

- Creepage and arcing in the primary circuit will endanger the equipment;
- Leakage, short circuit in the secondary circuit, control failure;
- The thermal resistance of the radiator increases, and the temperature of the SCR increases.

- Clean up dust

- Use a clean and dry brush to gently brush away the dust;
- Blow off the dust with compressed air.

- Condensation

If frost is formed, the insulation level of the soft starter will be reduced, and the soft starter may not work properly.

- Creepage and arcing in the primary circuit will endanger the equipment;
- Leakage, short circuit in the secondary circuit, control failure;
- Strengthen the seat corrosion of metal parts.

- Dry

- Drying with electric blowing or electric furnace;
- Dehumidification in the power distribution room.

**Schedule 1. Application field**

Mechanical type	Load type	Starting mode			Value setting		Rise time
		Voltage	Current	Heavy load	Voltage (%)	Current (%)	
Centrifugal pump	Standard load		•			250	5
Fan	Heavy load		•	•		400	40
Compressor (piston type)	Standard load		•			300	10
Compressor (centrifugal type)	Standard load	•			30		20
Conveyor machine	Standard load		•			250	10
Blender	Standard load		•	•		350	5
Ball mill	Heavy load		•	•	70	400	50
Crusher	Heavy load	•			60		45

## Schedule 2. Specification and parameter of peripheral accessories

SJR3-5000 Series Soft Starter( 5.5KW~ 55KW )

Model	Rated power (kw)	Rated current (A)	SCPD specification	Supporting circuit breaker model(QF)	Supporting bypass contactor model (KM)	Specification of primary cable	Remark
SJR3-5005	5.5	11	RS0-20	TGM1-63L /16	CJ20-16	2.5mm <sup>2</sup> cable	For 55KW and below, use cable to lead out the wiring, the method is six in and three out. Rated power rated current refers to the max. value of the soft starter.
SJR3-5007	7.5	15	RS0-30	TGM1-63L /25	CJ20-16	4mm <sup>2</sup> cable	
SJR3-5011	11	23	RS0-50	TGM1-63L /32	CJ20-25	6mm <sup>2</sup> cable	
SJR3-5015	15	30	RS0-80	TGM1-63L /40	CJ20-40	10mm <sup>2</sup> cable	
SJR3-5018	18.5	37	RS0-80	TGM1-63L /50	CJ20-40	10mm <sup>2</sup> cable	
SJR3-5022	22	43	RS0-80	TGM1- 63L/63	CJ20-63	16mm <sup>2</sup> cable	
SJR3-5030	30	60	RS0-100	TGM1-63L /80	CJ20-63	25mm <sup>2</sup> cable	
SJR3-5037	37	75	RS0-150	TGM1-63L/100	CJ20-100	35mm <sup>2</sup> cable	
SJR3-5045	45	90	RS0-200	TGM1-63L/125	CJ20-100	35mm <sup>2</sup> cable	
SJR3-5055	55	110	RS0-200	TGM1-63L/160	CJ20-160	35mm <sup>2</sup> cable	

Note: The specification parameter list of peripheral accessories is for reference

SJR3-5000 Series Soft Starter( 75KW~320KW )

Model	Rated power (kw)	Rated current (A)	SCPD specification	Supporting circuit breaker model(QF)	Supporting bypass contactor model (KM)	Specification of primary cable	Remark
SJR3-5075	75	150	RS0-300	TGM1-225U200	CJ20-250	35mm <sup>2</sup> cable	For 75KW and above, the cable is used to lead the wiring, and the method is six in and three out. Rated power rated current refers to the max. value of the soft starter.
SJR3-5090	90	180	RS0-320	TGM1-225L7225	CJ20-250	30x3mm <sup>2</sup> copper wire	
SJR3-5115	115	230	RS0-480	TGM1-400U315	CJ20-250	30x3mm <sup>2</sup> copper wire	
SJR3-5132	132	260	RS0-600	TGM1-400U315	CJ20-400	30x4mm <sup>2</sup> copper wire	
SJR3-5160	160	320	RS0-600	TGM1-400L7350	CJ20-400	30x4mm <sup>2</sup> copper wire	
SJR3-5185	185	370	RS0-700	TGM1-400U400	CJ20-400	40x4mm <sup>2</sup> copper wire	
SJR3-5200	200	400	RS0-700	TGM1-630L7500	CJ20-400	40 x 4mm <sup>2</sup> copper wire	
SJR3-5250	250	500	RS0-800	TGM1-630U630	CJ20-630	40x5mm <sup>2</sup> copper wire	
SJR3-5280	280	560	RS0-1000	TGM1-63017630	CJ20-630	40x5mm <sup>2</sup> copper wire	
SJR3-5320	320	640	RS0-1000	TGM1-800U700	CJ20-630	40x5mm <sup>2</sup> copper wire	

Note: The specification parameter list of peripheral accessories is for reference

SJR3-5000 Series Soft Starter( 400KW~630KW )

Model	Rated power (kw)	Rated current (A)	SCPD specification	Supporting circuit breaker model(QF)	Supporting bypass contactor model (KM)	Specification of primary cable	Remark
SJR3-5400	400	800	/	DZ20Y <sup>^</sup> 1250/3300 1000A	CJ40-800	50 x 6mm <sup>2</sup> copper wire	For 400KW and above, the cable is used to lead the wiring, and the method is six in and three out. Rated power rated current refers to the max. value of the soft starter.
SJR3-5450	450	900	/	DZ20Y1250/3300 1000A	CJ40-1000	50 x 6mm <sup>2</sup> copper wire	
SJR3-5500	500	1000	/	DZ20Y1250/3300 1250A	CJ40-1000	60 x 8mm <sup>2</sup> copper wire	
SJR3-5630	630	1200	/	DZ20Y1250/3300 1250A	CJ40-1200	60 x 8mm <sup>2</sup> copper wire	

Note: The specification parameter list of peripheral accessories is for reference

## Warranty Agreement

1. If the product fails within 12 months from the date of purchase, but not more than 18 months after the date of manufacture recorded on the nameplate, the company provides free maintenance services if the product fails under normal storage and use.
2. During the warranty period, if the following situations occur, the company will charge a certain amount of maintenance fees depending on the situation.
  - a) Failures caused by failure to strictly follow the "Instruction Manual" or exceed the standard specifications in the environment required by the "Instruction Manual";
  - b) Failure caused when the product is used for abnormal functions;
  - c) Failure caused by self-repair or modification without permission;
  - d) Damage caused by improper storage, fall or other external factors after purchase;
  - e) Failures caused by natural disasters such as abnormal voltage, lightning, water mist, fire, salt corrosion, gas corrosion, earthquakes, storms, or accompanying disasters;
  - f) Unauthorized tearing up of product identification (such as tearing off labels, nameplates, etc.); the body does not match the warranty card.
3. The service fee is calculated according to the actual cost. If there is another contract, the contract shall be given priority.
4. If you have any questions, you can contact the agent or contact our company directly.
5. For products that exceed the warranty period, our company also provides lifetime paid maintenance services!



**China Technical Service Headquarter**

**Manufacturer: Shanghai Sanyu Industry Co.,Ltd.**

**Address: Room 723, No.800 Shangcheng Road, Shanghai, China**

**Tel: +86-21-65046976**

**Fax: +86-21-51686158**

**Postal code: 201980**

**Website: [www.sanyuacdrive.com](http://www.sanyuacdrive.com)**

**E-Mail: [alansunrise@sina.com](mailto:alansunrise@sina.com)**

**The technical parameters are subject to change without notices.**

**All rights reserved.**

**Figures herein are for information only.**